

Small Flow Gas Coalescing Assembly

Description

Small Flow Gas (SFG) Coalescing Assemblies are rugged, inexpensive, high efficiency assemblies that eliminate problems caused by oil, water, and dirt in air or gas.

Performance Specifications

- Removal of 99.99% of all aerosols 0.3 microns and larger. Typical downstream aerosol concentrations are less than 0.003 ppm.
- Patented surface treatment that prevents liquids from wetting the coalescer media allowing for higher gas flow capacity and lowered fouling tendency and differential pressure.
- Consistent performance using thin fibers and fixed pore construction optimized for efficient coalescing.
- Long service life due to pleated media structure and surface treatment.
- Low energy losses with typical saturated pressure drop of 1.2 psid (82.7 mbard).
- Wide range of compatibility for use with process gases, compressor oils, hydrocarbon condensates, and water.

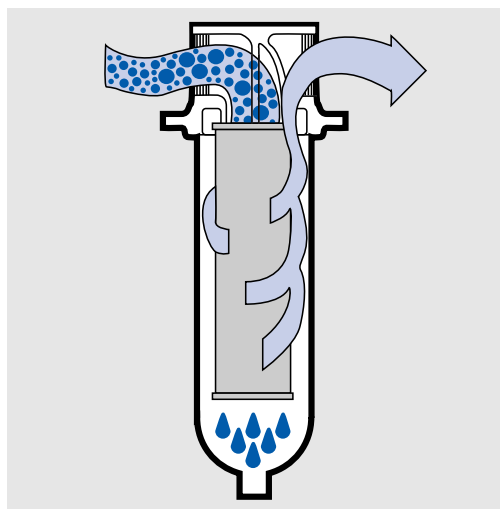

Inside to Out Flow Pattern of SFG Coalescer Assembly



SFG Coalescer Features

Positive Seal: Standard seal material is Nitrile (H13) available as either an internal o-ring or flat gasket depending on coalescer size.

Outer Drainage Layer: Drainage of coalesced liquid and protection from re-entrainment is provided by a polymeric outer drainage layer. This ensures consistent, high efficiency performance.

Metal Support Core: Axial strength and protection against liquid slugs are provided by a perforated inner support core constructed of 304 stainless steel.

Outer Cage: Media support during operation is provided by a 304 stainless steel outer support cage.

Primary Coalescer: Coalescing is achieved by use of a high area pleated glass fiber medium that is surrounded by a non-woven polymeric support and drainage layers. A patented surface treatment is used that enhances coalescer performance and lowers fouling tendency and pressure drop.

End Caps: 304 stainless steel end caps are used to improve cartridge strength and prevent contaminant bypass.

Key Benefits

- Protects process analyzers
- Safeguards instrument air operated equipment and systems
- Prevents orifice plugging in pneumatic controllers
- Improves accuracy of gas measurements in the field or plant
- Decreases freeze-out and corrosion problems
- Reduces fouling in small gas-driven engines
- Provides reproducible high-quality gas for all operations using produced gas

SFG Coalescer Element Specifications

Coalescer Part Number ¹	PFS4463ZMH13	PFS1001ZMH13
Coalescing Efficiency at 0.3 μm	99.99%	99.99%
Rated Flow Air @ 100 psig (6.9 barg) and 100°F (38°C)	60 scfm (8.3 acfm)	200 scfm (27.6 acfm)
Effective Coalescer Area	0.84 ft ² (0.078 m ²)	2.2 ft ² (0.204 m ²)
Clean Saturated Pressure Drop	0.53 psid (36.54 mbar)	1.5 psid (103.4 mbar)
Maximum Temperature (water present)	140°F (60°C)	140°F (60°C)
Maximum Temperature (no water)	250°F (121°C)	250°F (121°C)
Maximum Differential Pressure ²	50 psid (3.4 barg)	50 psid (3.4 barg)
Dimensions:	2¼ in O.D. x 5¼ in (57.2 mm O.D. x 133.4 mm)	2¾ in O.D. x 9¾ in (69.9 mm O.D. x 247.7 mm)
Sealing Mechanism	Single open-ended with internal o-ring	Double open-ended with gaskets / tie rod

¹ Standard seal material is Nitrile (H13). Fluorocarbon Elastomer (H) and Ethylene Propylene (J) are also available for optimum fluid compatibility.

² A change out differential pressure of 15 psid is recommended to ensure efficient operation.

MDS4463GN80MFH13



6" min for bowl removal

MDS4463G3455

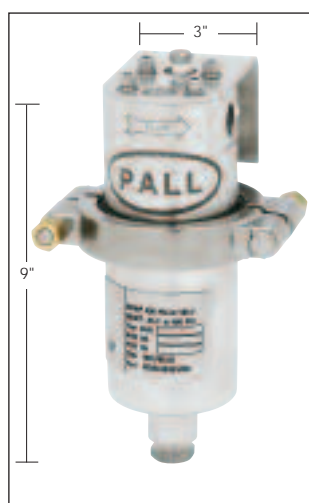

7" min for bowl removal

CCL4001G160H13



10" min for bowl removal

MEN9001G240H

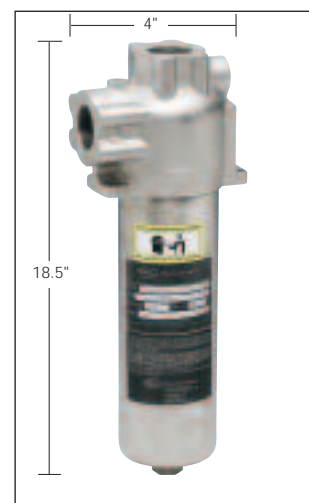

9" min for bowl removal

SFG Coalescer Housing Specifications

SFG Housing Part Number	Housing Material of Construction	Replacement Cartridge	Design Pressure (psi/bar)	Number of Cartridges	Weight (lb/kg) Dry	Weight (lb/kg) Wet	Connection & Drain Sizes (NPT) (in/mm)
MDS4463GN80MFH13	316 SS	PFS4463ZMH13	150/10.3	1	3.6/1.7	5.7/2.6	0.5/12.7
MDS4463G3455	316 SS	PFS4463ZMH13	400/27.6	1	15.0/6.8	22.0/10.0	0.5/12.7
CCL4001G160H13	316 SS	PFS1001ZMH13	400/27.6	1	7.0/3.2	13.0/5.9	1.0/25.4
MEN9001G240H	Nickel Plated Carbon Steel	PFS1001ZMH13	4000/275.8	1	26.0/11.8	32.0/14.5	1.5/38.1

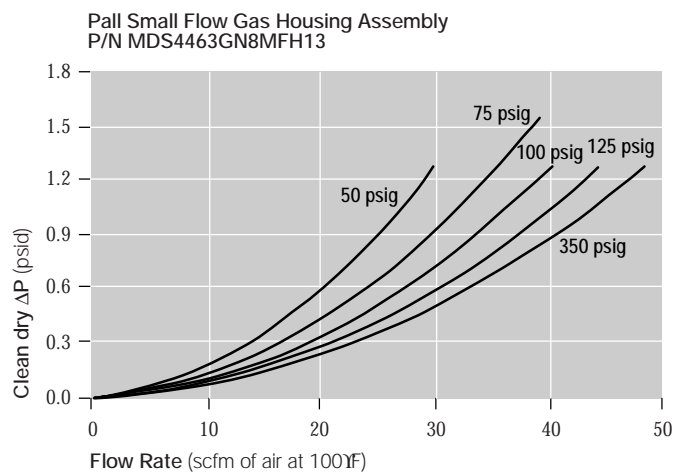
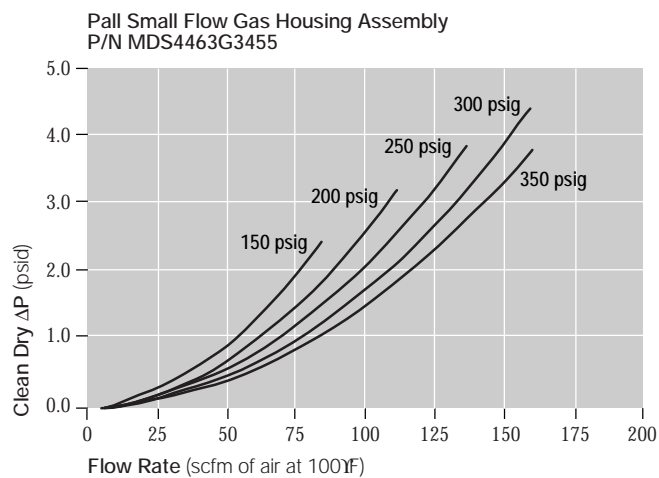
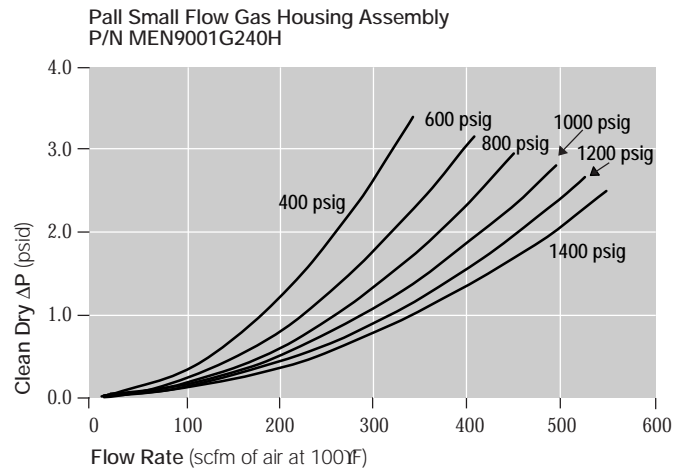
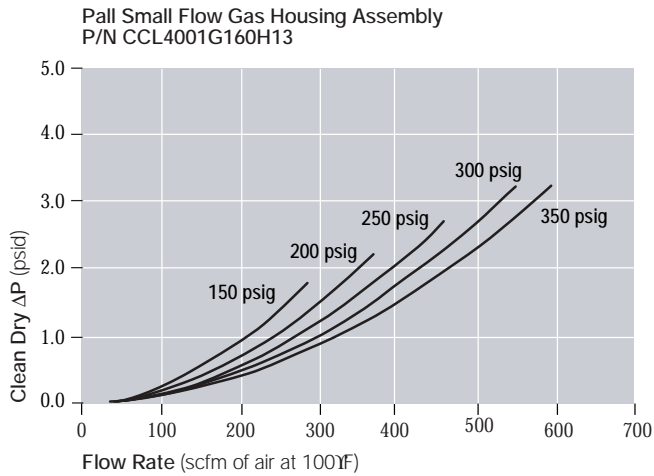

To calculate the pressure drop for other process conditions use the following equation:

$$P = K_H Q_A^2 \rho + K_C Q_A \mu$$

where :

- P: pressure drop in psid
- K_H : housing pressure drop constant
- Q_A : actual flow rate in acfm
- ρ : gas density at operating conditions in lb/ft³
- K_C : coalescer pressure drop constant
- μ : gas viscosity at operating conditions in cP

Coalescer Assembly P/N	K_H	K_C
CCL4001G160H13	0.00267	0.2703
MEN9001G240H	0.00973	0.2703
MDS4463G3455	0.04346	0.6864
MDS4463GN8MFH13	0.07000	0.6864

Pall Corporation

A Powerful Resource For Control Protection and Teamwork

Pall Corporation brings 60 years of filtration and separations experience to your plant's processes. With the industry's widest range of advanced products, Pall can design a system specifically for your plant, based on a thorough evaluation of your needs.

You'll receive technical consultation and support from our Scientific and Laboratory Services Department (SLS). SLS represents a large global network of scientists and engineers spanning more than 30 Pall laboratories worldwide.

Pall continues to develop new products and methods to advance the state of the art of phase separation. No other company offers such a strong core competency in coalescing technology to help you reduce operating and maintenance costs through improved product control, plant protection and teamwork.

For more information, contact your local Pall distributor. Additional information on Pall products and services can be found at our web site: <http://www.pall.com>.



Pall Corporation

Corporate Headquarters

2200 Northern Boulevard
East Hills, New York 11548-1289
888.873.7255 toll free
516.484.5400 phone
516.484.0364 fax
fuelsandchemicals@pall.com

United Kingdom

Europa House, Havant Street
Portsmouth P01 3PD
Hampshire, England
+44 (0) 23 9230 2357 phone
+44 (0) 23 9230 2509 fax
processuk@pall.com

Filtration. Separation. Solution.SM

Visit us on the Web at www.pall.com

Because of developments in technology the data or procedures may be subject to change. Consequently we advise users to review their continuing validity annually.

Pall Corporation has offices and plants throughout the world in locations including: Argentina, Australia, Austria, Belgium, Brazil, Canada, China, France, Germany, India, Indonesia, Ireland, Italy, Japan, Korea, Malaysia, Mexico, the Netherlands, New Zealand, Norway, Poland, Puerto Rico, Russia, Singapore, South Africa, Spain, Sweden, Switzerland, Taiwan, Thailand, United Kingdom, United States, and Venezuela. Distributors are located in all major industrial areas of the world.

© Copyright 2006, Pall and  are trademarks of Pall Corporation.

® Indicates a Pall trademark registered in the USA.

Filtration. Separation. Solution.SM is a service mark of Pall Corporation.